

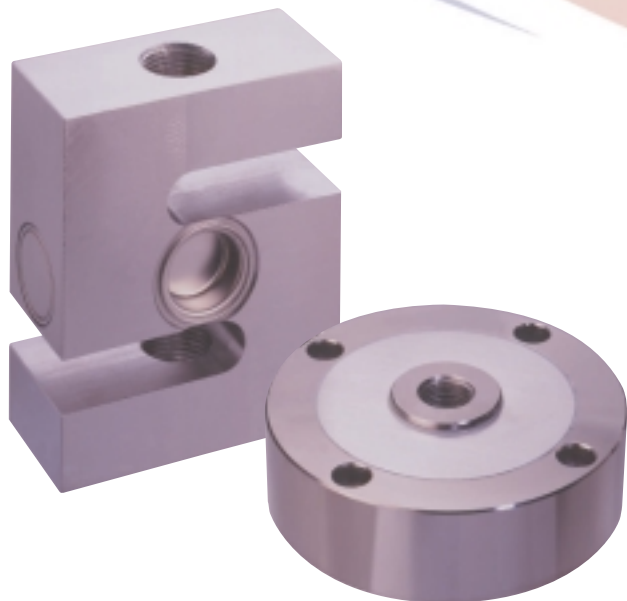

TRACKER 240 SERIES

Load Cell and Weighing Indicators



A Precision Measurement Instrument
with Outstanding Features

TRACKER 240 SERIES INDICATORS

- Ratiometric Measurement**
- Tare and Auto Zero
- Transducer Excitation Supply**
- Max / Min Memory
- Isolated Analogue Output**
- Digital Status Inputs
- 'In-Flight' Compensation**
- Part Counting And Peak Picking
- Adjustable Display Resolution**
- Universal Power Supply
- Serial Communications**
- Alarm and Control Outputs

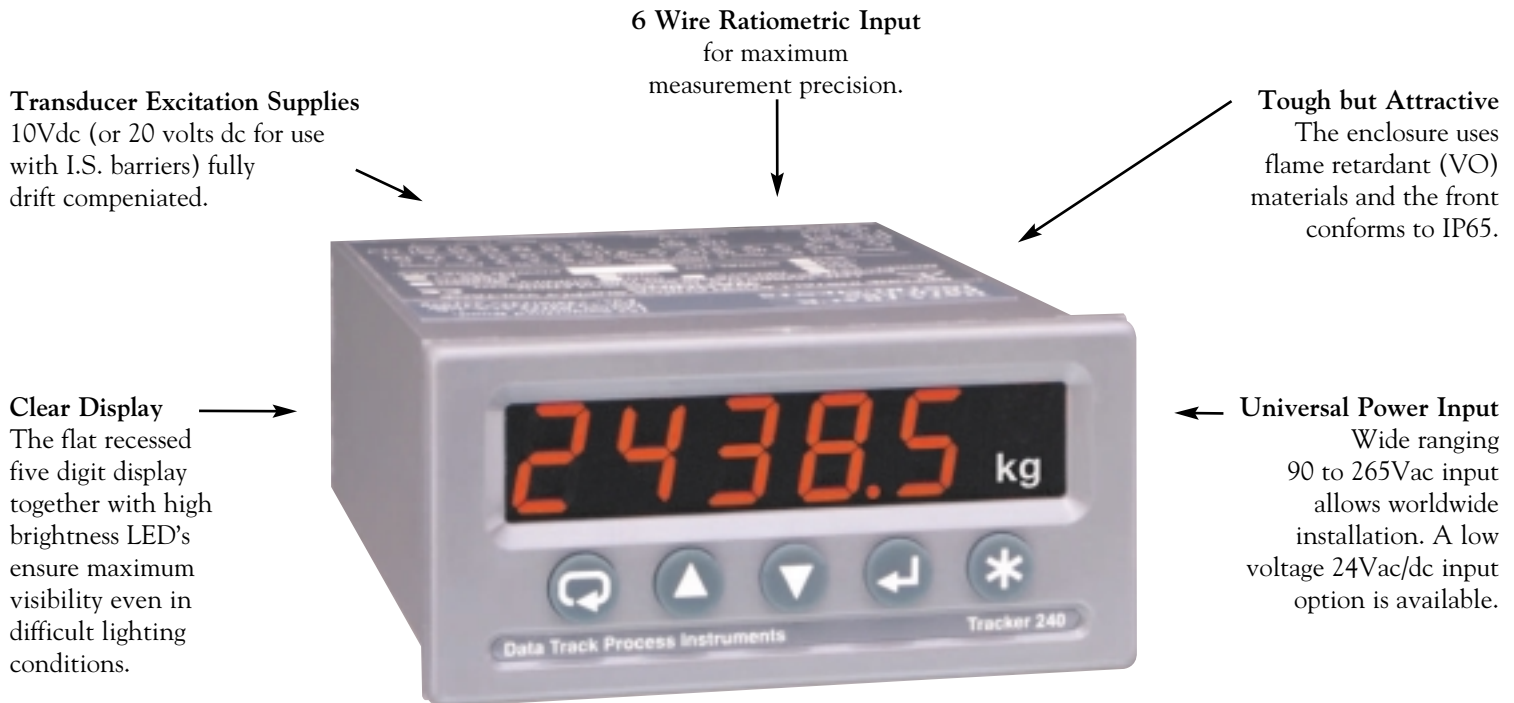

The Tracker 240 series of digital panel indicators are designed specifically for use with load cell transducers and for weighing applications. All the Tracker 240 series models have a 5 digit display and transducer supply plus many software features including tare, offset zeroing, 'in-flight' compensation, 'peak picking' and extensive alarm functions.

As standard the Tracker 240 series are fitted with an analogue output and an RS 422/485 communications interface to allow connection to data loggers, chart recorders, PLCs and computers. All models have the same specification except that the T244 has two relay outputs to control external devices and the Tracker 245 has four TTL logic outputs. The displayed value can be in tonnes, litres, grams or any other engineering unit.

The Tracker 240 series can be used in conjunction with up to four 300 Ohm load cells, and uses a 6-wire ratiometric measurement technique. Power for the load cells can be provided from the internal regulated supply or from an external supply.

TRACKER 240 APPLICATIONS

Fill and (optional) Trickle Feeder Control

The Tracker 240 series relay or TTL outputs can be used to control filling of a container which is placed on a single load cell or on multiple load cells wired in parallel. The container weight can be compensated for by using the 'Tare' or 'Zero' function. The Tracker 240 controls the (high speed) feed device and, at a user definable point during the filling, switches off the high speed fill and switches on an optional Trickle (low speed) feed to achieve an accurate total fill weight. (See also 'in-flight' compensation below.)

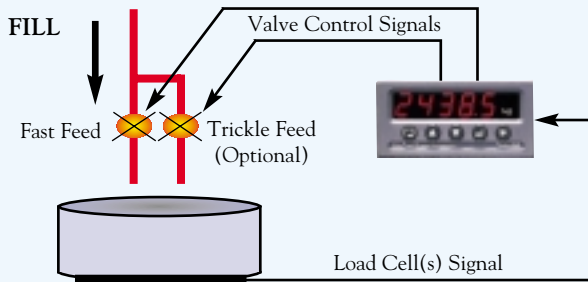

Loss of Weight/Discharge Control

This feature calculates the loss of weight of the feeder reservoir, rather than measuring the weight of the vessel that is being filled. Again both a 'fast' feeder and an optional 'trickle' feeder system may be used. The Tracker 240 will measure and control, by use of a logic or relay output, the loss of a pre-set weight of product to the container to be filled. Alarm outputs can also be used to indicate if the reservoir tank is too low or full. The fill command can be entered externally via a logic input, or by pressing a front panel function button.

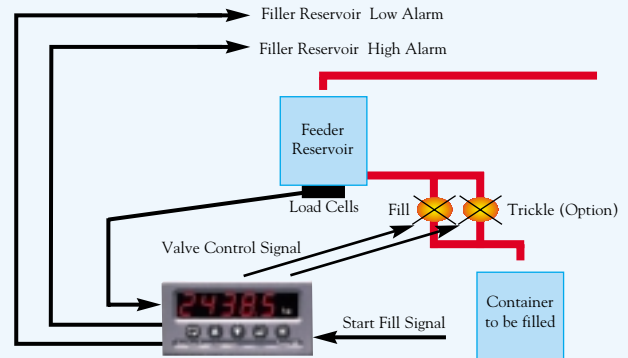

Automatic In-Flight Compensation

In-flight compensation allows the filling system to switch off the filler valve before the correct weight has been reached. This may be required if some of the product could be delivered for a time after the filler control valve has been switched off. The In-flight compensation can be applied to both the main feed and trickle feed controls outputs.

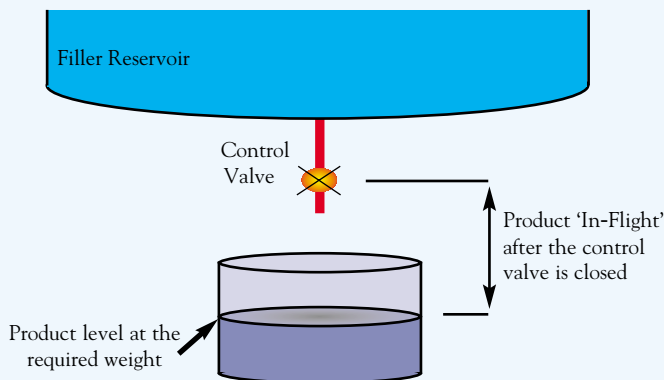

Learn Function

A learning function allows the Tracker 240 series to automatically correct the in-flight compensation, so increasing the accuracy of the delivered weight. This compensation is particularly useful when the product's flow rate characteristics change, perhaps due to variations in moisture or temperature. The 'learn' system constantly adjusts the switching point to optimise for changing product condition.

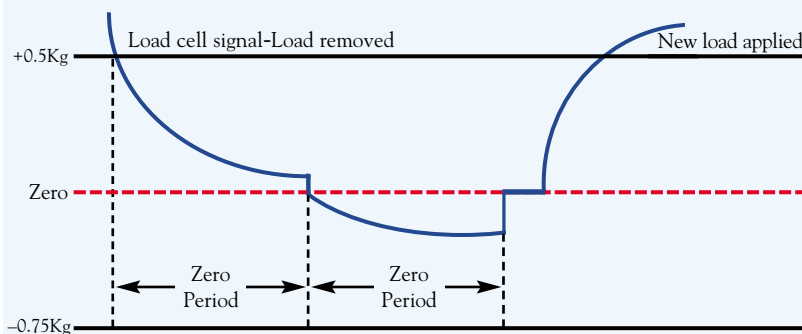

Peak Picking

This useful feature allows filled containers to be checked for weight, an alarm being activated if the weight falls outside pre-set limits. To eliminate false peak values being displayed due to the load being 'dropped' on to the load cells, a delay can be set before the measurement is displayed and the alarms become operational after crossing a defined threshold level. This delay is programmable between zero (off) and 10 seconds to 0.1 second resolution. The measured value is displayed until the next load is weighed. Alarms are only active while a load is being weighed and after the delay period.

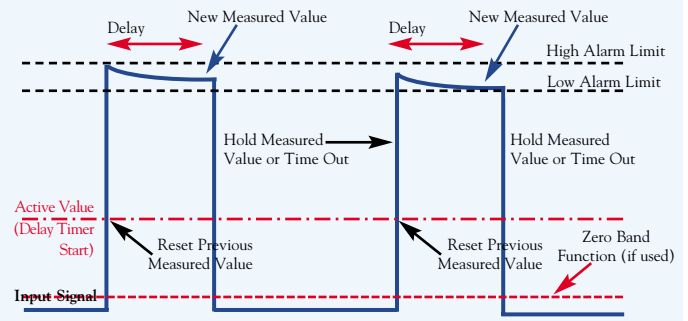

Auto Setpoint Adjustment

For the 'peak picking' application described above, there may be a slight change in the overall weight of the product over time. This may be due to slight differences in the container weight, for example. If a slight error from the setpoint value is seen, the setpoint can be automatically adjusted in a similar way as described in the in-flight 'learn' feature described opposite. If an alarm is activated (due to the weight being out of limits) the setpoint correction is ignored for that measurement cycle. Limits can be set to inhibit the maximum amount of setpoint correction that can occur.

Automatic Zeroing Band Function

Due to the hysteresis of some load cells, the measured value may not return to exactly zero when a load is removed. This function allows the user to set an error band around zero where the Tracker 240 will automatically initiate a zeroing of the measured value, if the reading is within the pre-set band. The error band can be set to any displayable value, and high and low limits can be individually entered. The automatic zeroing band function is repeated as long as the measured value is within the pre-set band, and removes the need to manually 'zero' the instrument before the next load is measured. The time period between zeroing is user selectable.

Part Count Function

A 'part count' function can be enabled by using a status (logic) input or a front panel push button. The Tracker 240 is used to weigh a single part or known number of parts, this measured value is then used to calculate the total number of parts in a batch.

TRACKER 240 FEATURES

Display

The user can configure the Tracker 240 series for the required engineering units and display resolution. The resolution is user configurable for 1, 2, 5 and 10 digits. This can be useful if a steady reading is difficult to achieve. Normally the full resolution would be displayed. For noisy signals an independent display filter is provided. The user can select the display update rate to be 2, 4 or 10 per second, and the brightness can be adjusted to suit ambient lighting conditions.

Digital Status (Logic) Inputs

Two logic inputs are provided to allow remote control of the indicator functions via external devices such as switches or PLCs. The inputs may be activated by volt free contacts or open collector TTL outputs. The two inputs can be individually programmed by a user to perform one or more of the following functions:-

- Tare
- Zero
- Part Count
- Display Hold
- Display Maximum (Peak)
- Display Minimum (Valley)
- Display Average
- Display Reset (Peak Picking Mode)
- Display Test (Lights all Display Segments)
- Keyboard Lock
- Alarm (Latch) Reset
- Alarm Disable
- Analogue Output Hold
- Reset Max, Min and Average
- Start Fill

Alarm Menus

Alarms can be flashed on the display along with the measured value. The user can individually configure the following parameters for each of the four alarm menus:-



- High, Low or Deviation Alarm Action
- High and Low Band Limits (Deviation Action Only)
- On and Off Delay Timers
- On and Off Hysteresis
- Latching or Non-Latching
- Normal or Pulsed Output Modes
- Setpoint Adjustment (During normal running or only via password protected menus)

When filling modes are selected, Digital (TTL/Relay) outputs 1 and 2 are automatically assigned.

Calibration Scaling and User Linearisation

Calibrating the Tracker 240 series to load cells can be achieved in one of two ways. Values from the strain gauge can be entered manually or the Tracker can read the actual output from the transducer at two points in the range, normally at zero and another point near the maximum load to be measured. These measured values are stored with their associated display values as the calibration parameters. For more demanding applications, up to 8 points can be independently calibrated to compensate for transducer non linearity.

Front Panel Function Keys

The five front panel buttons can be used to set up a unit by stepping through a simple password protected menu. In addition the two front panel function buttons marked  and  can be individually programmed by a user to give operator level access to one or more of the following functions.

- Tare
- Zero
- Part Count
- Display Hold
- Display Maximum (Peak)
- Display Minimum (Valley)
- Display Average
- Display Reset (Peak Picking Mode)
- Reset Max, Min and Average
- Display Test (Lights all Display Segments)
- Start Fill

Analogue Output

The user programmable analogue output allows the Tracker 240 series to transmit the measured display value or the Maximum, Minimum, Average, or a value sent via the serial interface. The analogue output can be scaled for any portion of the display range and is configurable for 4-20mA, 0-20mA or 0-10 Volt signals. Electrical isolation ensures that problems with earth loops are avoided.

Serial Communications

The Tracker 240 series are equipped with an isolated RS422/485 serial communications interface to allow connection to computers or PLCs. Three protocols are provided as standard to allow easy integration with most SCADA packages. The user can select 'Master Mode' to allow digital transmission to a remote 'Repeater' display or printer. RS232 can be supplied instead of RS422/485 - consult your supplier.

Sensor Connections

The Tracker 240 series use a 6-wire ratiometric method of measurement. Up to four 300 ohm load cells can be connected in parallel. More can be used if the resistance is higher (e.g. 8 x 600 ohm load cells) and the total current does not exceed 120mA at 10Vdc. An external 10Vdc supply can be used, if required, still retaining the ratiometric measurement capability. Normally the transducer connections would be wired as shown.

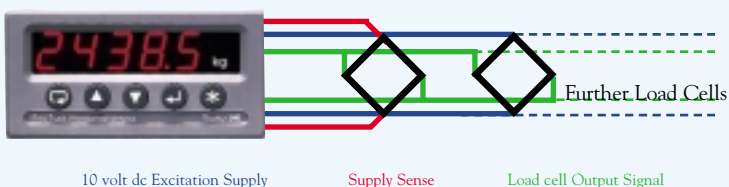

TRACKER 240 FEATURES

Smart Filter

Often plant vibration can effect the measured values and make the display appear "noisy". The Tracker 240 has a smart filter that samples the "noisy" signal from the load cells and then calculates a filter band value.

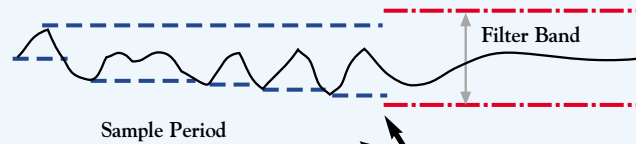

The Tracker stores the highest and lowest reading taken from approx. 100 samples to determine the "noise" amplitude.

The filter band is then calculated using the max/min stored values from the sampling period. The filter band can also be manually adjusted or turned off.

When in use, the filter is only applied when the measured value rate of change is within the filter band. To allow a fast response for real change of signal the filter is turned off until the signal rate of change is again within the filter band limits.

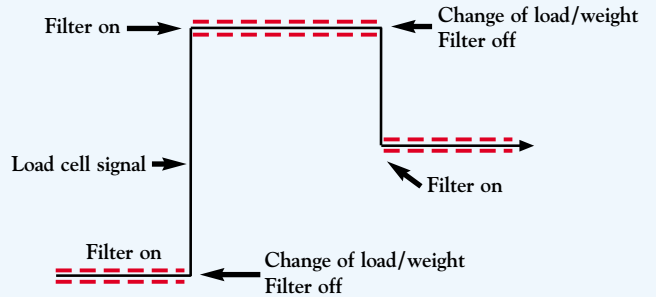

Serial Communications

A RS485 Serial interface is fitted as standard on all Tracker 240 models. Optionally a RS232 interface can be fitted (at extra cost) instead of RS485. The main applications are shown below.

Connection to a remote display

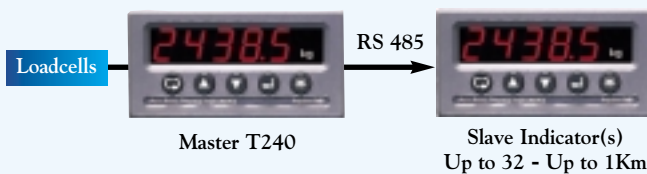

Connection to a printer

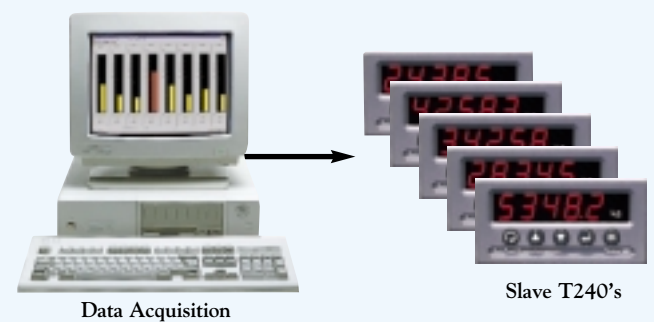
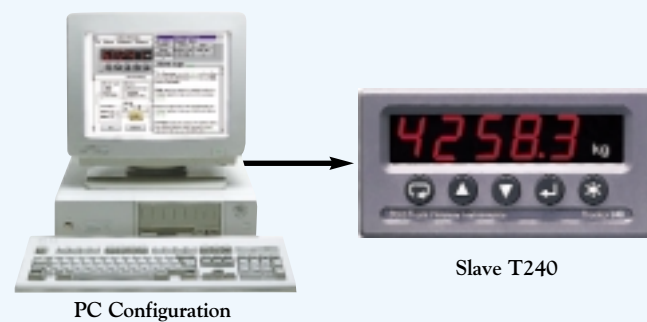
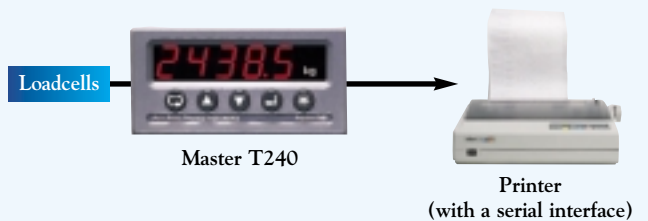

Connection to HMI (Human Machine Interface)

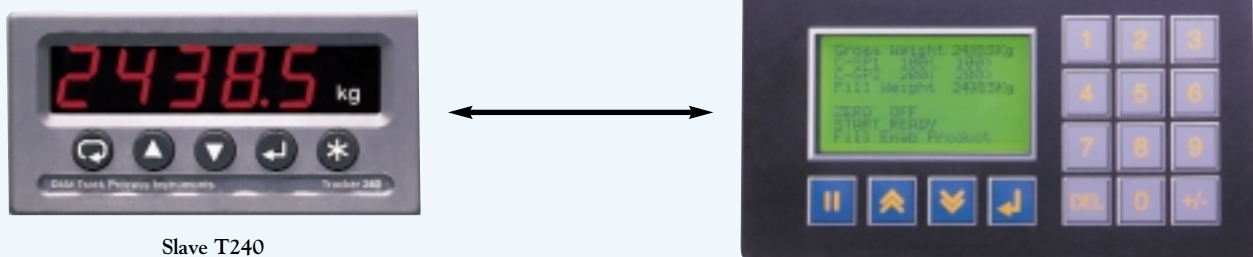

The combination of a Tracker 240 and an HMI, fitted with a Modbus compatible RS485 interface, becomes a powerful stand-alone batch control system and recipe selection system. The HMI's display and function buttons can be tailored for any application and language. Many HMI units can also be a gateway for Fieldbus connection (e.g. Profibus, Device Net). A single HMI can communicate with up to 32 Tracker 240 units.

TRACKER 240 CONFIGURATION

Technical Specification

Display

Range: -19999 to 99999
Type: Red (standard) or green LED 14.7mm high
Measurement resolution: User selectable (decimal point)
Update rate: Selectable 2, 4 or 10 per second
Resolution: Selectable 1, 2, 5 or 10 digits

Input

ADC Type: Sigma delta, 18 bit resolution (1 part in 262, 144)
Measurement mode: Ratiometric
Range: 0.5 to 20mV per Volt
Connection: 6 wire - 2 x excitation, 2 x sense, 2 x signal
Accuracy: Better than 0.02% of reading
Measurement rate: 20 per second
Input impedance: >100M Ω
Common mode rejection: >150dB
Series mode rejection: >70dB

Transducer Supply Output

Regulated 10Vdc @ 120mA
(To power up to 4 x 300 Ω Load cells wired in parallel)
A 20Vdc output can be supplied for use with I.S. barriers -
consult with supplier

Digital Outputs

Tracker 244 only - 2 off, single change over (form C)
contacts rated at 1A @ 240Vac, 5A @ 30Vdc
Tracker 245 only - 4 off, TTL open collector

Outputs can be energised or de-energised in the alarm
condition or configured to give a pulse output

Function Keys and Status (Logic) Inputs

Functions can be user assigned to two of the front panel
buttons and the two digital inputs. The digital inputs can be
switched by external volt free contacts or TTL signals.

Serial Communications

Type: RS 422/485, 2 or 4 wire multidrop
Isolation: To 500Vdc/Peak ac
Speed: 1200, 2400, 4800, 9600 baud.
Parity: Odd, even or none.
Stop bits: 1 or 2
Protocols: MODBUS™ RTU (J-BUS), MODBUS™ ASCII
and DTPI (Data Track Process Instruments) in
master or slave mode.



Tracker 240 indicators have been
tested and comply with the European
Electromagnetic Compatibility Directives
and safety requirements. The units are
CE marked.



Analogue Output

Isolation: 500Vdc/Peak ac
Output: User selectable 0-10V, 0-20mA or 4-20mA
Scaling: User scaling to any displayable value
Accuracy: Better than 0.2%
Temperature drift: <100 ppm per °C
Response: 63% within 32mS, 99% within 100mS
Resolution: 0.05% (5mV or 0.01mA)
Maximum voltage output: 11V @ 22mA
Maximum current output: 22mA @ 18V
Maximum load: 900 Ω
Programmable output damping filter

Power Requirements

Universal 90 to 265Vac, 50 or 60Hz @ 20VA nominal
Optional 24Vdc/ac supply

Environmental

Temperature: 10 to 50 °C operating
-10 to 70 °C storage
Humidity: 10 to 95% RH non condensing

Physical/Mechanical

Dimensions: 48mm (H) x 96mm (W) x 173mm (D)
Panel cut-out: 44mm (H) x 92mm (W)
Depth behind panel: 166mm including terminals
Weight: 0.4kg, (0.55kg packed weight)

Safety and EMC

Safety: EN61010
Susceptibility: EN50082-1 & 2
Emissions: To EN50081-1 & 2
EN50022 Class A for radiated and conducted
CE Certified 1997

Ordering Code

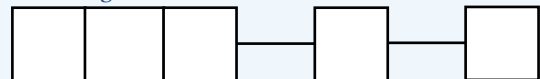

Model Number

Supply

Display Colour

Model Number:

- 243 Load Cell Indicator
- 244 Load Cell Indicator with Dual Alarm Relays
- 245 Load Cell Indicator with Quad TTL Alarm Outputs

Supply:

- 1. 90-250Vac
- 2. 24Vdc/ac

Display Colour:

- R Red (Standard)
- G Green (Option)

Example: 244-1-G

Tracker 244 Load Cell Indicator with Dual Alarm Relays,
Mains Powered and Green Display.

Distributed by

CompuMess Elektronik GmbH

Lise-Meitner-Str.1, 85716 Unterschleissheim

Tel 089-321501-0 Fax 089-321501-11

<http://www.compumess.de> oder <http://www.netzteile.de>